

ARPEGE 40-55-70-75-110-140-170
NATAL 40

USER AND MAINTENANCE GUIDE

AIR LIQUIDE - DMC

Parc Gustave Eiffel - 8, avenue Gutenberg
Bussy-Saint-Georges - 77607 Marne La Vallée Cedex 3 - France
Tel.: 33 1 64.76.15.00 - Fax: 33 1 64.76.16.99
Site: www.dmc.airliquide.com

CONTENTS

1	GENERAL	4
1.1	THE APPARATUS	4
1.2	THE PERSONNEL	4
1.3	REMINDER ABOUT UNPACKING INSTRUCTIONS	5
1.4	THE INSTALLATION/ENVIRONMENT	5
1.4.1	<i>Limiting environment conditions</i>	5
1.4.2	<i>The installation</i>	5
1.4.3	<i>Start-up</i>	7
1.4.4	<i>Precautions to be taken if the apparatus is completely emptied</i>	8
1.5	USE	8
1.5.1	<i>Open the lid</i>	8
2	CONTAINER CHARACTERISTICS	9
2.1	PARTICULAR SAFETY INSTRUCTIONS	9
2.2	RECOMMENDATIONS	9
2.3	MATERIALS IN DIRECT OR INDIRECT CONTACT WITH THE USER	9
2.4	DIMENSIONS OF THE MEDICAL APPARATUS	10
2.5	OVERALL DIMENSIONS	11
2.5.1	<i>ARPEGE 40 – 70 – 110 – 140 – 170 – NATAL 40</i>	11
2.5.2	<i>ARPEGE 55 - 75</i>	12
2.6	MEASUREMENT SCALE	13
2.6.1	<i>ARPEGE 40 – NATAL 40</i>	13
2.6.2	<i>ARPEGE 55</i>	14
2.6.3	<i>ARPEGE 70</i>	15
2.6.4	<i>ARPEGE 75</i>	16
2.6.5	<i>ARPEGE 110</i>	17
2.6.6	<i>ARPEGE 140</i>	18
2.6.7	<i>ARPEGE 170</i>	19
2.7	THE CAPACITIVE LEVEL GAUGE	20
2.8	THE CAPACITIVE LEVEL GAUGE IN THE GAS PHASE	20
3	TRANSPORT AND HANDLING INSTRUCTIONS	21
4	SERVICING AND MAINTENANCE	21
4.1	SERVICING OF THE APPARATUS	21
4.2	PREVENTIVE MAINTENANCE	22
4.3	REMEDIAL MAINTENANCE	23
	INDICATORS ONLY:	23
4.3.1	<i>Temperature + regulated level indicator</i>	23
4.3.2	<i>Temperature & Level indicators + 4-20 mA unit</i>	23
4.3.3	<i>Temperature & Level indicators + RS485 unit</i>	23
4.3.4	<i>Functional anomalies</i>	24
5	WASTE ELIMINATION METHOD	26
6	METHOD OF ELIMINATING THE CRYOGENIC CONTAINER	26
7	SYMBOLS & ABBREVIATIONS	26

8	SPARE PARTS AND ACCESSORIES	27
8.1	SPARE PARTS.....	27
8.2	ACCESSORIES/OPTIONS.....	28
8.3	INTERNAL EQUIPMENT	29
8.4	INTERNAL GAS PHASE EQUIPMENT	30
9	APPENDIX.....	32

AIR LIQUIDE reserves the right to modify the characteristics given in this document without notice.



Only personnel who have read this guide in full and the safety instructions in document NH78380 are authorised to manipulate and use the apparatuses described in this document.

Like all equipment, your device may suffer an electrical or electronic fault. The manufacturer cannot be held liable for stored products of any nature and which might be lost as a result of this fault, even during the warranty period.

1 GENERAL

1.1 THE APPARATUS

Depending on accessories used with them, ARPEGE 40 – 55 – 70 – 75 – 110 – 140 – 170 and NATAL 40 units are used to store and keep previously frozen biological elements in the liquid or gas phase at very low temperature.

The apparatus must be used exclusively for storage with liquid nitrogen. No other gas shall be used.

Note the following properties:

ARPEGE 40 — 70 — 110 – 140 and 170

- ✓ Storage systems in baskets for boxes of 2 & 5 mL tubes
- ✓ Storage in the liquid or gas phase
- ✓ Modulable options depending on the need including:
 - ▶ Temperature reading
 - ▶ Programmable level indication or indication and regulation (except NATAL & ARPEGE 40)
 - ▶ Remote monitoring of parameters (Temperature, Level, etc.) (except NATAL & ARPEGE 40)

For ARPEGE 55 and 75

- ✓ Various canister and rack storage systems adapted to ampoules, straws, pouches, tubes, etc.
- ✓ Large opening for easy access
- ✓ Identical options.

Also for NATAL 40

- ✓ Derived from the GT40 with a canister storage system
- ✓ Identical options.

1.2 THE PERSONNEL

Only persons who have read this guide in full and the safety instructions are authorised to manipulate and use the cryogenic apparatus.

Only the distributor or a fully trained person is authorised to do any work on the medical apparatus if the cryogenic apparatus appears to be malfunctioning under normal usage conditions. The user must not do any work on the system himself because this could be harmful to his or her health and/or safety.

1.3 REMINDER ABOUT UNPACKING INSTRUCTIONS

Take safety precautions by respecting safety rules and using individual protection equipment and tools adapted to unpacking.

At least two persons are necessary for unpacking the medical apparatus.

Unpack the medical apparatus as close as possible to its usage location, to avoid the need for handling over an excessively long distance.

1. Check the condition of the packing on delivery.
2. Cut the straps
3. Remove the cover
4. Remove the apparatus from the box gently (**two persons**). Then put it into place.

1.4 THE INSTALLATION/ENVIRONMENT

1.4.1 Limiting environment conditions

Technical characteristics and correct operation of the apparatus are valid for the following conditions:

During operation:

Ambient temperature $20^{\circ}\text{C}^{\pm 2^{\circ}\text{C}}$ (sheltered from direct sunlight)

Relative humidity from 30% to 65% without condensation

Storage: (In its original packaging)

Ambient temperature from 5°C to 40°C

Relative humidity from 10% to 65%

1.4.2 The installation

The operator of the apparatus is responsible for assuring that the room complies with regulations, safety standards in force and the following recommendations.

If a single pipe is used for the supply, a degassing system is necessary either on the pipe (degasser pot/purger) or on the apparatus (See §8.2 Accessories page 28). The nitrogen gas supply may reduce the quality of stored products, and in exceptional cases can put the apparatus in fault by evaporation of the remaining liquid nitrogen.



The maximum liquid nitrogen supply pressure must be less than 3 bars: the use of a higher pressure can damage the solenoid valve or prevent it from functioning correctly.

The capacity of the supply receptacle will depend on the quantity of the liquid between the minimum level and the maximum filling level. This capacity must always be at least 100 litres.

Before connecting the filling hose to the supply receptacle or to the liquid nitrogen network, it is important to blow dry nitrogen through the pipes to eliminate all traces of humidity (risk of creating an ice plug when liquid nitrogen or cold gas passes through).

Installation CHECK-LIST

	Yes DONE	NO NOT DONE
Check the general condition of the apparatus.	<input type="checkbox"/>	<input type="checkbox"/>

Are users trained?	<input type="checkbox"/>	<input type="checkbox"/>

Does the room satisfy safety regulations and standards in force?	<input type="checkbox"/>	<input type="checkbox"/>

Are the dimensions of the room adapted to installation of the medical apparatus?	<input type="checkbox"/>	<input type="checkbox"/>

Is access to the room limited to persons entitled to enter it?	<input type="checkbox"/>	<input type="checkbox"/>

Are safety instructions and risks related to liquid nitrogen posted?	<input type="checkbox"/>	<input type="checkbox"/>

Are instructions accompanying the medical apparatus available/accessible close to it?	<input type="checkbox"/>	<input type="checkbox"/>

Is individual protection equipment available/accessible in the room?	<input type="checkbox"/>	<input type="checkbox"/>

Is the room equipped with a permanent ventilation system adapted to the size of the room?	<input type="checkbox"/>	<input type="checkbox"/>

Is the room equipped with an oxygen content checking system (display outside the room)?	<input type="checkbox"/>	<input type="checkbox"/>

Are safety distances respected (at least 0.5 m around the apparatus)?	<input type="checkbox"/>	<input type="checkbox"/>

Is the apparatus connected to a liquid nitrogen supply (network or supply container)?	<input type="checkbox"/>	<input type="checkbox"/>

Is the 220V-24V power supply fixed to the wall?	<input type="checkbox"/>	<input type="checkbox"/>

Are fittings on the apparatus in position (if applicable)?	<input type="checkbox"/>	<input type="checkbox"/>

Is the liquid nitrogen supply pressure less than 3 bars?	<input type="checkbox"/>	<input type="checkbox"/>

Has the medical apparatus being blown through (to eliminate all traces of humidity)?	<input type="checkbox"/>	<input type="checkbox"/>

1.4.3 Start-up

All the steps in the previous chapter should be validated before starting up an apparatus.

We recommend that at least one person should be present at all times to monitor filling until completion.

WARNING: Do not force fittings and connectors when starting up. Check that male/female connections correspond to each other.

It is indispensable to place all of the storage units inside the recipient itself, even if they are empty. A storage unit that has not been conditioned to the temperature of the recipient before its introduction leads to a significant rise in the temperature and a safety risk for the user.

Start-up CHECK-LIST (Before each use)

	YES DONE	NO NOT DONE
<p>{A} Connect power supply cables for electrical equipment (indicators, auxiliary systems and units) to the 220V/24V power supply provided with the apparatus or to the (4-20mA / RS485) unit depending on the case.</p> <p><u>WARNING:</u> The anti-overflow system must be connected to a power supply independent from the other electrical devices.</p>	<input type="checkbox"/>	<input type="checkbox"/>
<p>{B} Connect the 220V/24V power supply to the electrical network</p> <p><u>Note:</u> All alarms will be triggered when power is switched on. You can choose whether or not to disable these alarms. If you are using a remote monitored device (4-20 mA or RS485), do not forget to inform the safety manager when your apparatus is switched on.</p>	<input type="checkbox"/>	<input type="checkbox"/>
<p>{C} If your apparatus is not equipped with an automatic regulation system, it can be filled in two different ways:</p> <ul style="list-style-type: none"> ▶ By pouring liquid nitrogen directly through the neck (for example filling from a TP fitted with a transfer hose). ▶ By a vacuum line connected to the ARPEGE filling tube through a "liquid nitrogen" fitting and a transfer hose. <p>Check the liquid nitrogen level regularly using the straight edge provided, and with reference to the measurement scales (see the corresponding diagram). Once the required level has been reached, stop filling.</p>	<input type="checkbox"/>	<input type="checkbox"/>
<p>{D} Else: Connect the transfer hose between the apparatus fitting (at the back of the apparatus, see diagram in APPENDIX) and the liquid nitrogen supply (network or supply container).</p>	<input type="checkbox"/>	<input type="checkbox"/>
<p>{E} If you are using storage in the liquid phase and you would like to modify the regulation and/or alarm thresholds of your apparatus, please refer to the indicator instructions.</p>	<input type="checkbox"/>	<input type="checkbox"/>
<p>{F} When the apparatus is completely empty, you will need to start filling manually. To do this, press the manual control button (the location is shown on the corresponding diagram) until you see a few bars appear on the level indicator.</p>	<input type="checkbox"/>	<input type="checkbox"/>
<p>{G} <u>Storage in liquid phase</u> Once the empty level (0%) has been exceeded, press the manual filling button 4 times (within less than 2 seconds) to start semi-automatic filling. Your apparatus will then fill up to the high level threshold [UCL].</p> <p><u>WARNING:</u> This step can last several hours depending on the capacity of your apparatus.</p>	<input type="checkbox"/>	<input type="checkbox"/>

	YES DONE	NO NOT DONE
{H} After 30 minutes stabilisation, check that the level reached corresponds to the programmed level, with reference to the measurement scales (see the corresponding diagram) and the straight edge supplied. WARNING: It is normal that there will be a difference between the measurement made and the theoretical measurement, depending on the manufacturing tolerances and the measurement methods. This variation remains acceptable provided that it does not exceed 5%.	<input type="checkbox"/>	<input type="checkbox"/>
{I} Check the filling levels of the apparatus regularly for a week, for each configuration (they must be within the tolerances specified in the indicators guide).	<input type="checkbox"/>	<input type="checkbox"/>

1.4.4 Precautions to be taken if the apparatus is completely emptied

It is essential to dry the inside of the medical apparatus thoroughly by blowing through with nitrogen or dry de-oiled air. This is particularly important for the filling pipes and the level gauge.

There is a risk that these pipes could get blocked when refilling if this precaution is not taken, which would make filling impossible or cause a malfunction of the level gauge.

1.5 USE

1.5.1 Open the lid

The lid is fitted with a handling handle. Always manipulate it using the handle.

Note: The lid is fitted with a safety system. We recommend that you should leave your apparatus locked and never leave the key in the lock.

2 CONTAINER CHARACTERISTICS

2.1 PARTICULAR SAFETY INSTRUCTIONS

See the diagram of apparatuses in the Appendix

Precautions to be taken for the person during the work:

- ✓ Cold burns
 - ▶ On the hose support and the hose (back of the apparatus) during or immediately after filling
 - ▶ On the neck and the lid after opening
 - ▶ By splashing of liquid nitrogen during opening or use of accessories
- ✓ Hot burns
 - ▶ On the anti-overflow solenoid valve (back of apparatus)
- ✓ Trapping
 - ▶ By the lid when closing the apparatus
- ✓ Crushing
 - ▶ By the rollers and the apparatus when moving it
- ✓ Electrocution
 - ▶ By the power supply unit
- ✓ Cutting
 - ▶ By the hose support (back of the apparatus).

2.2 RECOMMENDATIONS

We recommend that you should always wear your individual protection equipment whenever you use the apparatus

2.3 MATERIALS IN DIRECT OR INDIRECT CONTACT WITH THE USER

- ✗ Stainless steel
- ✗ Aluminium alloy
- ✗ Brass
- ✗ Copper
- ✗ Cadmium plated steel
- ✗ Polycarbonate
- ✗ Polyurethane foam

2.4 DIMENSIONS OF THE MEDICAL APPARATUS

	NATAL 40	ARPEGE 40	ARPEGE 70	ARPEGE 110	ARPEGE 140	ARPEGE 170	ARPEGE 55	ARPEGE 75
Useful capacity	40	40	72	116	144	172	55	72
Weight empty (KG)	24	25	33	40	40	56	31	37
Weight full (KG)	57	57	91	134	156	195	75	95
Daily evaporation (L/d) ⁽¹⁾	0.29	0.29	0.6	0.6	0.65	0.7	2.4	2.5
Static endurance (day) ⁽¹⁾	140	140	130	193	222	246	23	29
Neck diameter (mm)	120	120	215	215	215	215	378	378

⁽¹⁾ *These values are given for apparatuses tested without any internal equipment. They are given for guidance and are arbitrary, and valid for generally observed usage conditions. They can vary depending on manufacturing tolerances and local atmospheric condition.*

2.5 OVERALL DIMENSIONS

2.5.1 ARPEGE 40 – 70 – 110 – 140 – 170 – NATAL 40

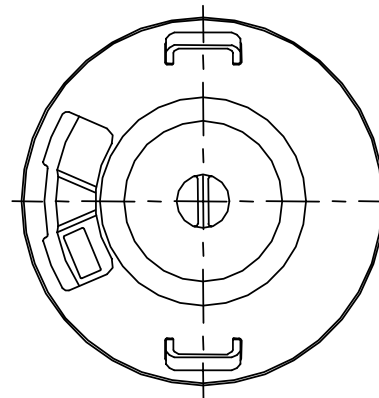
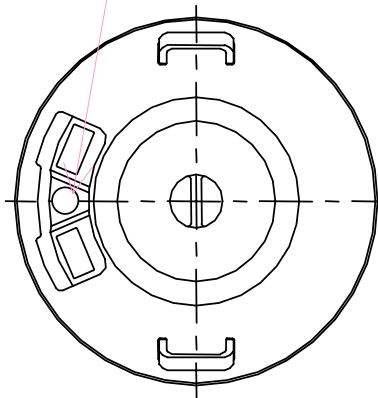
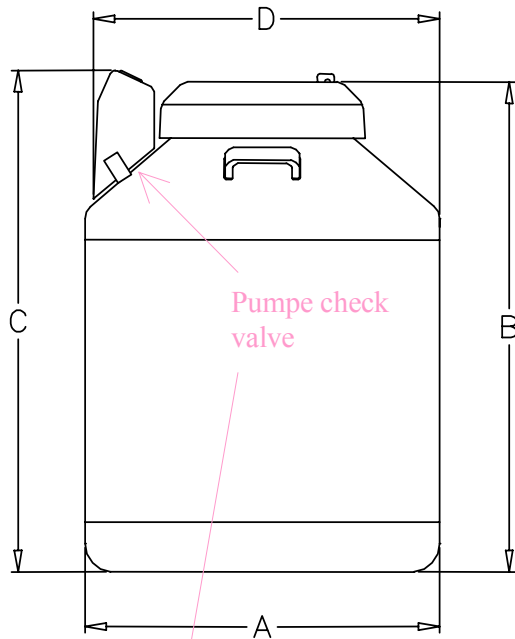

Option: level regulator display
and temperature display

Option: level regulator display
or temperature display

mm	NATAL40	ARPEGE 40	ARPEGE 70	ARPEGE 110	ARPEGE 140	ARPEGE 170
Ø A	468	467	586	586	683	683
B	710	735	738	962	911	1028
C	815	839	772	996	920	1028
D	450	502	673	673	720	720

2.5.2 ARPEGE 55 - 75

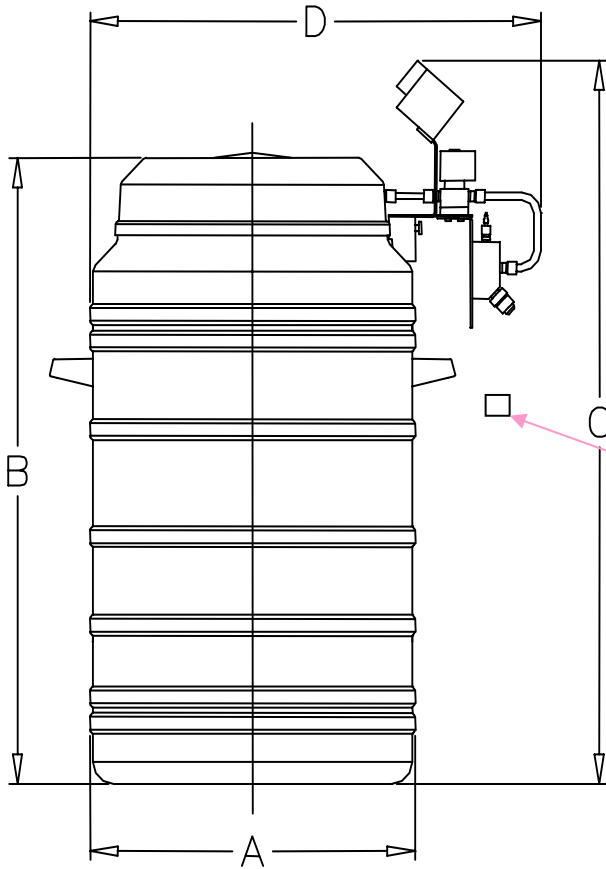

mm	ARPEGE 55	ARPEGE 75
A	468	468
B	850	1015
C	980	1145
D	650	650

Pump check valve

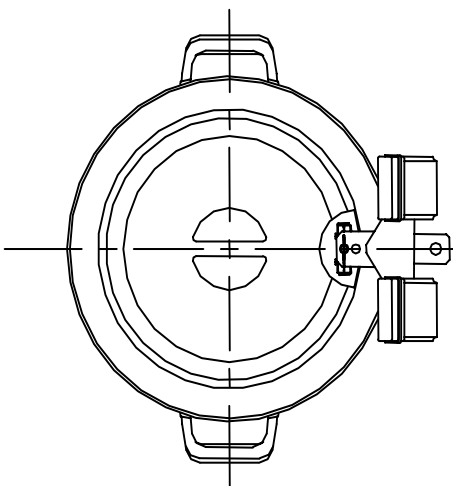

Option: level regulator display and temperature display

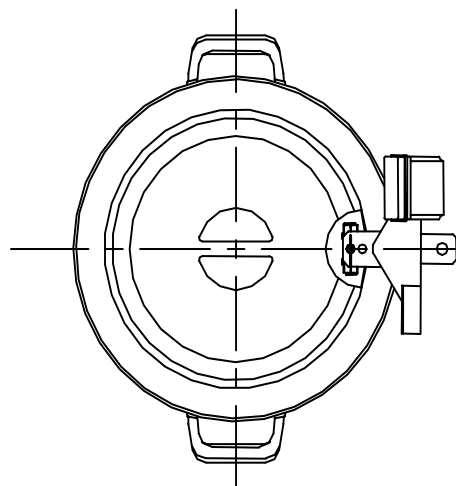

Option: level regulator display or temperature display

2.6 MEASUREMENT SCALE

2.6.1 ARPEGE 40 – NATAL 40

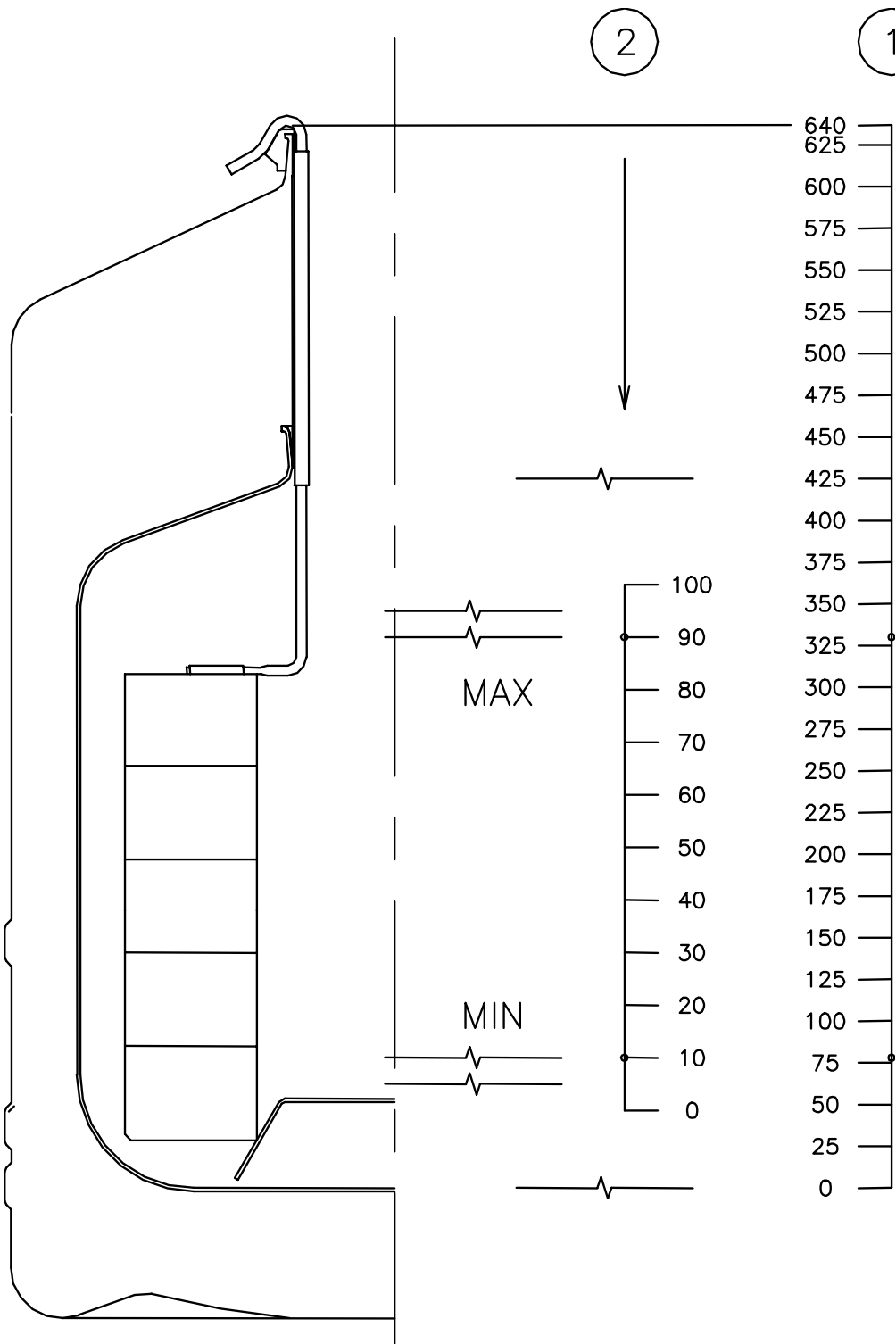

1 – Recorded heights (mm)

2 – Level in % measurement range

2.6.2 ARPEGE 55

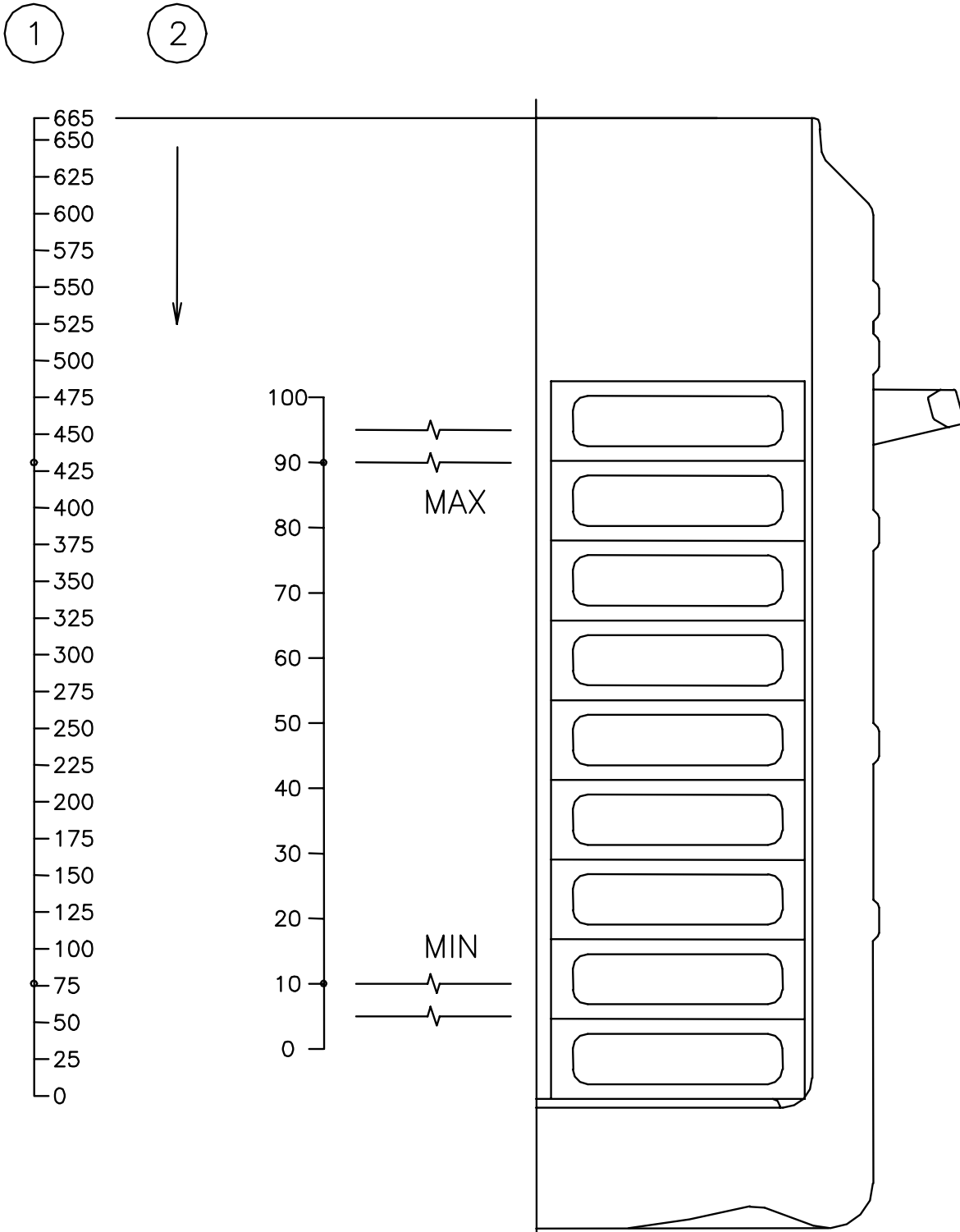

1 – Recorded heights (mm)

2 – Level in % measurement range

2.6.3 ARPEGE 70

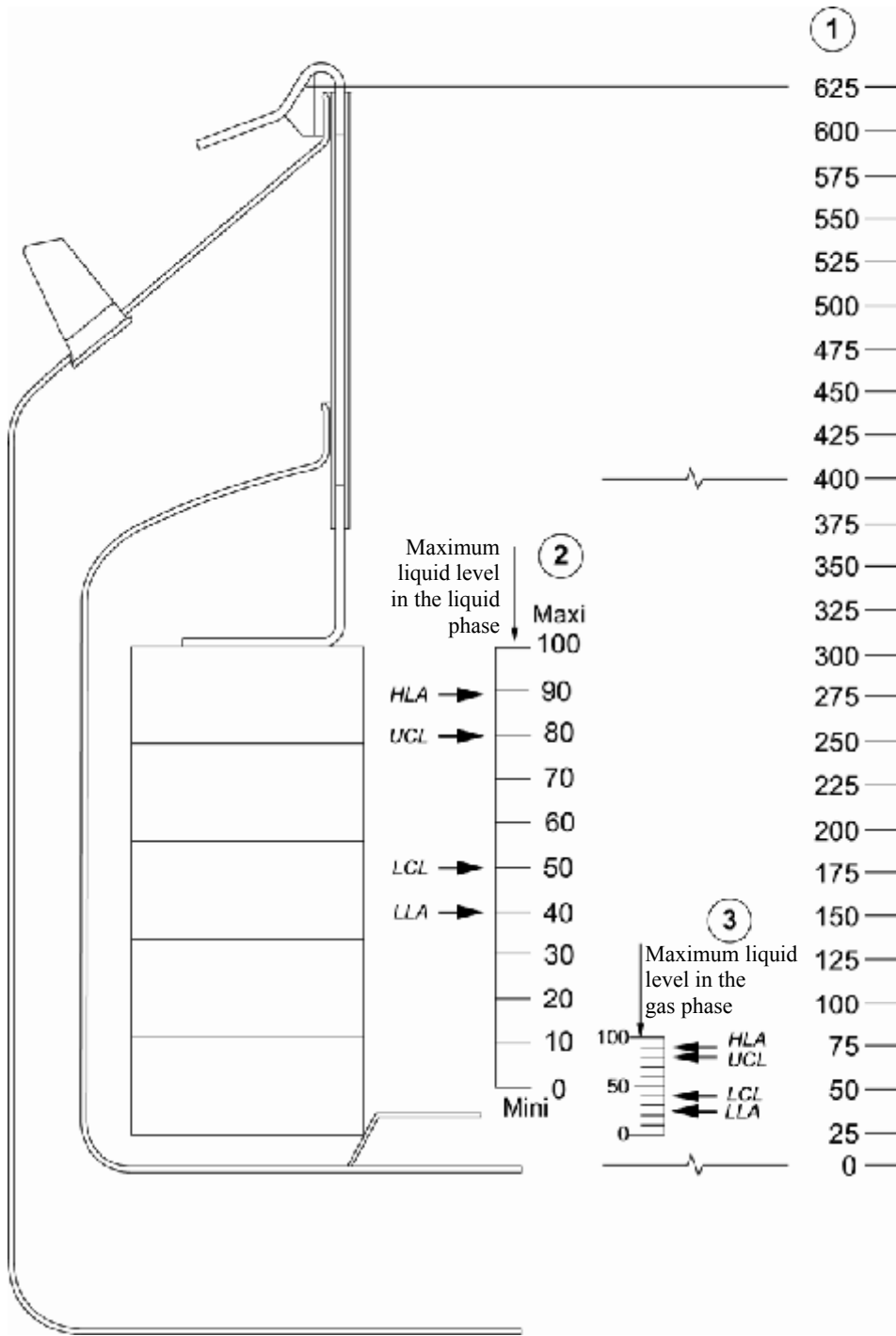

1 – Recorded heights (mm)

2 – Level in % measurement range in the liquid phase

3 – Level in % measurement range in the gas phase

2.6.4 ARPEGE 75

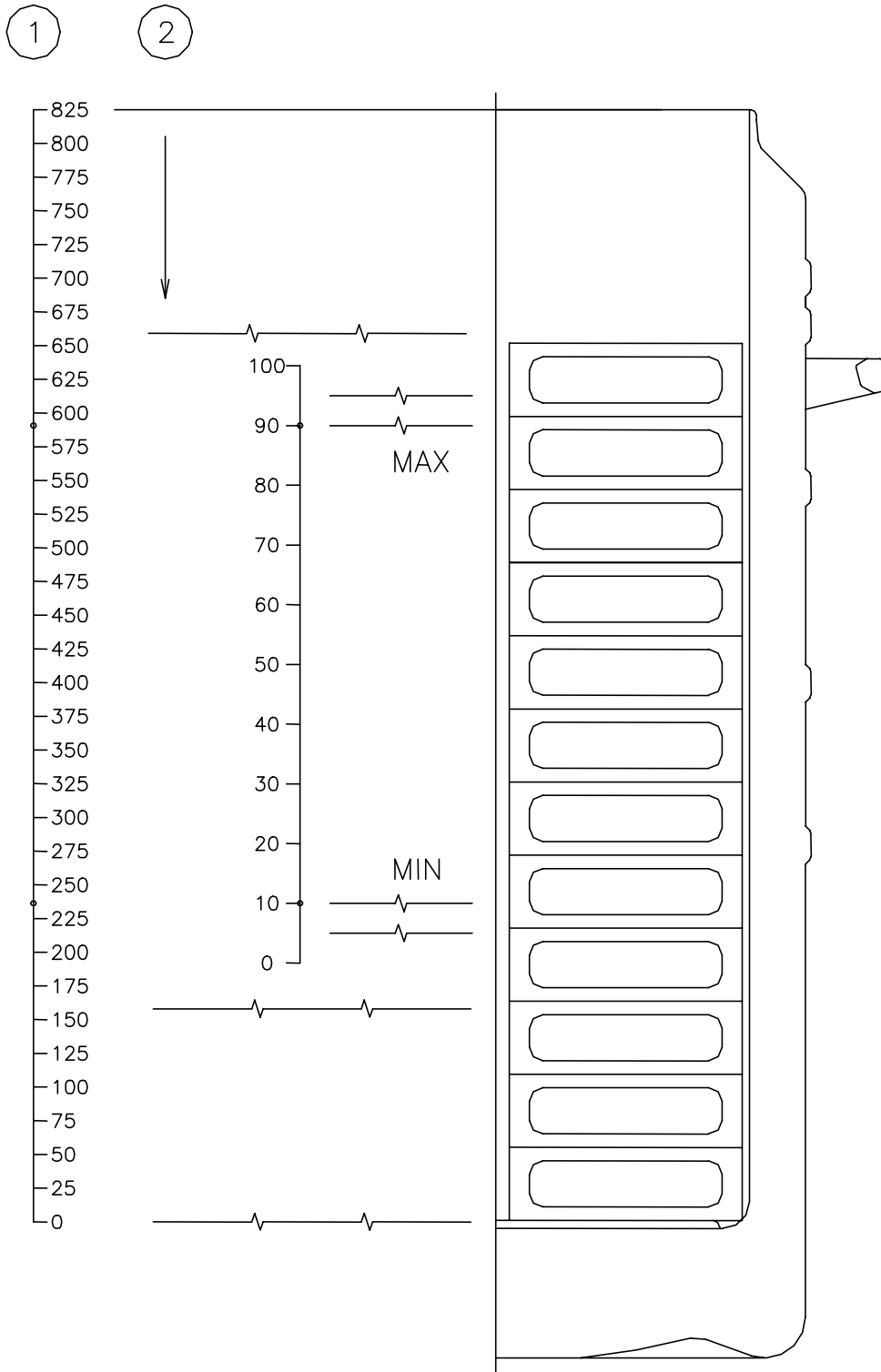

1 – Recorded heights (mm)

2 – Level in % measurement range

2.6.5 ARPEGE 110

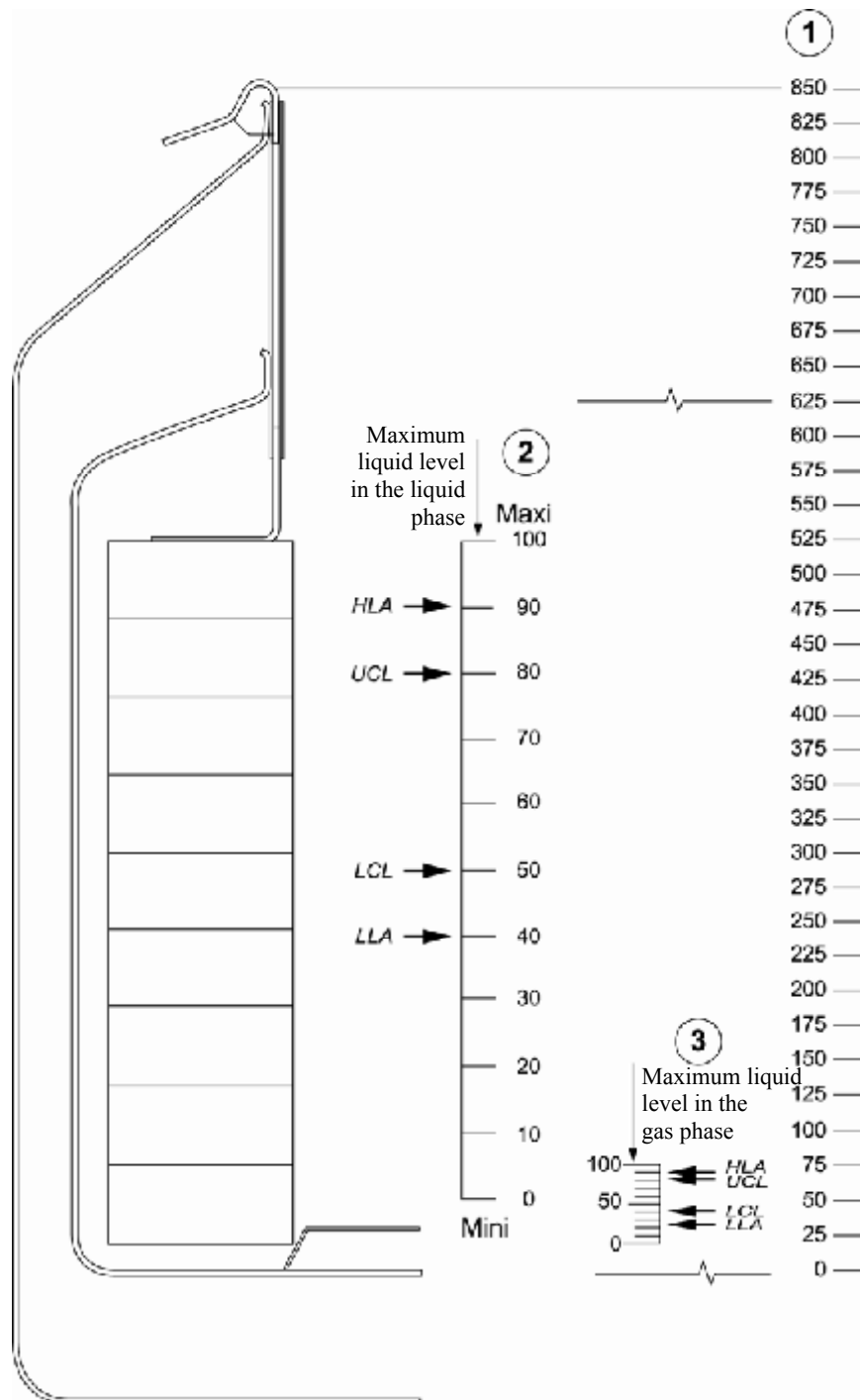

1 – Recorded heights (mm)

2 – Level in % measurement range in the liquid phase

3 – Level in % measurement range in the gas phase

2.6.6 ARPEGE 140

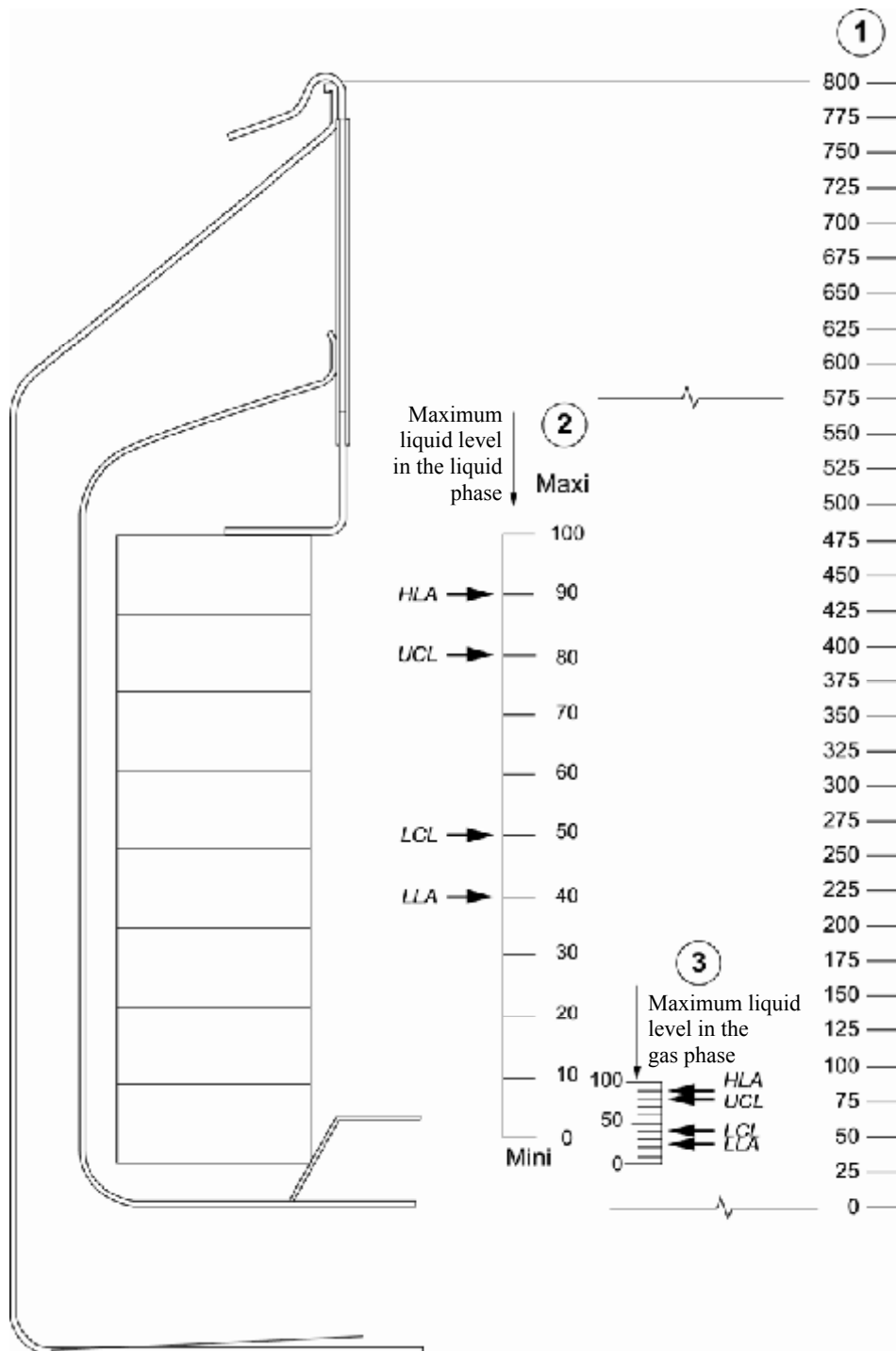

1 – Recorded heights (mm)

2 – Level in % measurement range in the liquid phase

3 – Level in % measurement range in the gas phase

2.6.7 ARPEGE 170

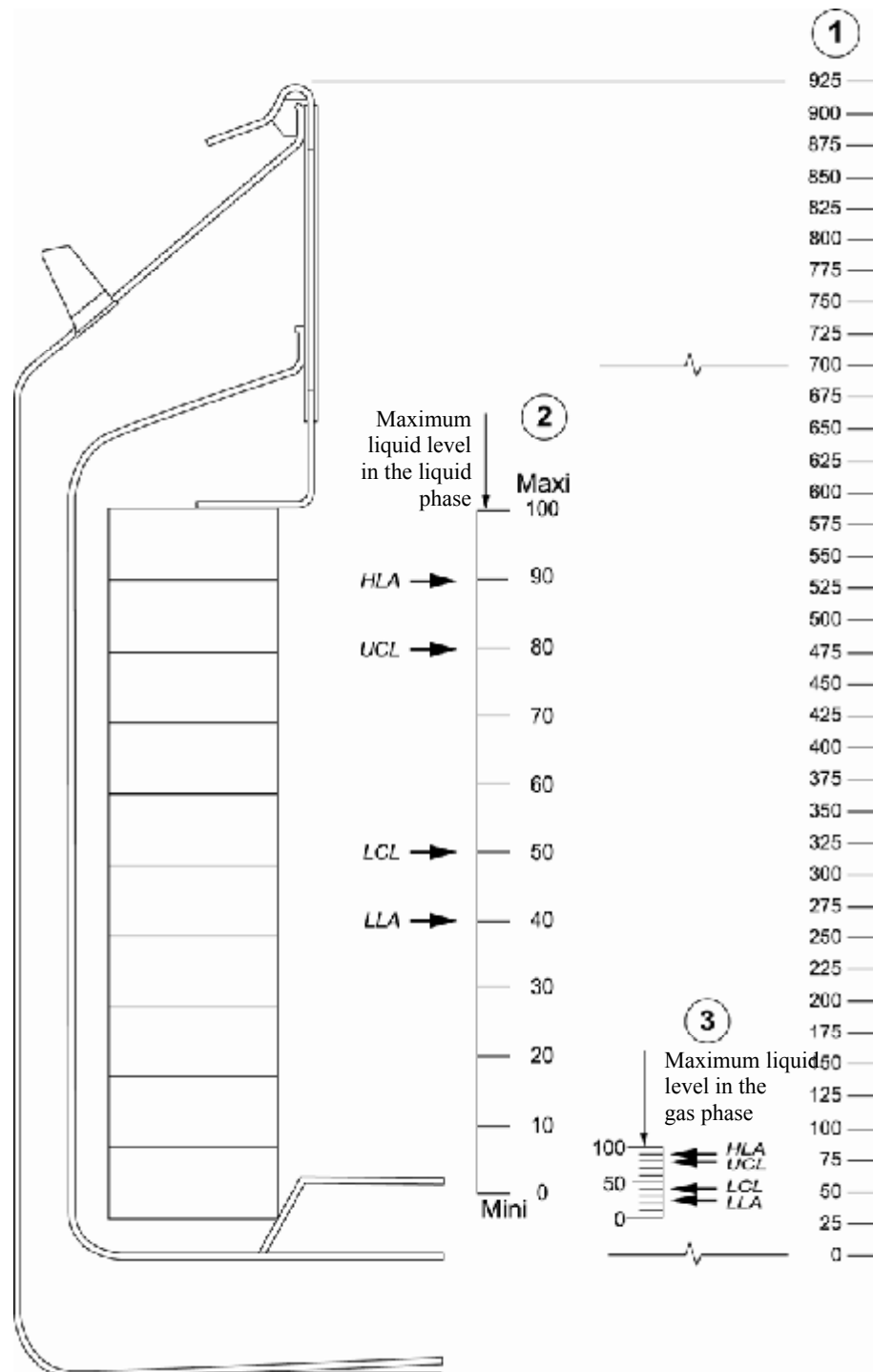

1 – Recorded heights (mm)

2 – Level in % measurement range in the liquid phase

3 – Level in % measurement range in the gas phase

2.7 THE CAPACITIVE LEVEL GAUGE

The measurement length of the liquid phase level gauge is adapted to each apparatus.

During regulation, the "factory setting" range is fixed at:

- ▶ Max level 80%
- ▶ Min level 50%

These values may be adjusted within the following limits:

- ▶ Maximum level between 90% and 20%
- ▶ Minimum level between 80% and 10% with a difference of not less than 10% between the minimum and the maximum.
- ▶ Refer to the indicators guide for further information.

NOTE: A cold level gauge removed from its well must be perfectly dried before being put back into place. (In this case, allow for oven drying of the lower part of the level gauge at 60° for several hours).

2.8 THE CAPACITIVE LEVEL GAUGE IN THE GAS PHASE

The level gauge for the gas phase has a measurement part that is common to all ARPEGE models in the gas phase range.

During regulation, the adjustment range is fixed at:

- ▶ Max level 80%
- ▶ Min level 40%

These values cannot be modified.

NOTE: A cold level gauge removed from its well must be perfectly dried before being put back in place. (In this case, allow for oven drying of the lower part of the level gauge at 60° for several hours).

3 TRANSPORT AND HANDLING INSTRUCTIONS

The apparatus **must be** empty for transport. It must always be transported in its original packaging, respecting instructions imposed by national and international regulations in force.

Always keep apparatuses in the vertical position and do not apply shocks to them.

Never stack apparatuses.

The apparatus may be handled by forklift truck according to standard practice, **only** when it is in its packaging.

Never use a forklift truck to handle the apparatus when it is not in its packaging, always move it by:

- if empty, two persons carrying it using its handles
- otherwise, rolling it on its bottom plate fitted with rollers (See §Accessories/Options). The bottom plate with rollers can only be used over short distances.

4 SERVICING AND MAINTENANCE

We recommend the following preventive/remedial servicing and maintenance operations, based on analyses of maintenance done on our cryogenic apparatuses over several years:

4.1 SERVICING OF THE APPARATUS

This chapter should be read by competent and qualified authorised persons to do servicing work.

Servicing is required to assure that the equipment remains under normal operating conditions. The operator of the apparatus is responsible for it.

These operations must be carried out with non-abrasive, non-cutting and blunt tools so as to avoid damaging the surfaces concerned.

OPERATION	FREQUENCY (*)
<p><u>DE-ICING THE LID AND THE NECK</u> Eliminate ice that forms on the lid and the neck. You can melt the ice using a hair-dryer. Take care with all plastic parts (lid, outer panels, etc.) All ice and/or water must be recovered so that it cannot fall into the apparatus</p>	2 WEEKS
<p><u>CLEANING THE OUTSIDE OF THE APPARATUS</u> <u>Important comment:</u> Cleaning is limited to the outside parts of the apparatus. The use of acetone, solvents or any other very inflammable product, or chlorine-based liquid, is <u>prohibited</u></p> <ul style="list-style-type: none"> * Wipe plastic parts with a dry cloth and if necessary with a slightly damp non-abrasive sponge (do not use abrasive powder), or with impregnated towelettes. * Routine household products (slightly abrasive ammonia creams) can be applied with a sponge for the store part and for stainless steel parts. Then rinse with a cloth soaked with a small quantity of water, wipe and allow to dry. 	5 WEEKS
<p><u>CLEANING THE INSIDE AND DISINFECTING THE CONTAINER</u> The apparatus can be disinfected if it is considered necessary. You must call upon an authorised company for this type of work. The operator is responsible for this work.</p>	Depending on the need determined by the operator

(*) *The frequencies given are for information and must be adjusted by the operator depending on how the apparatus is used*

4.2 PREVENTIVE MAINTENANCE

REMINDER: *Like every other system, your apparatus may be subject to an electrical, electronic or mechanical failure. The manufacturer cannot be held responsible for any type of stored products lost as a result of this failure, even during the guarantee period.*

Preventive maintenance operations shall be carried out by technicians who have received appropriate training.

Only use original spare parts.

Maintenance is necessary to guarantee that the condition of the equipment remains safe. The operator of the apparatus is responsible for this maintenance

OPERATION	FREQUENCY (*)
<u>REPLACING THE ANTI OVERFLOW SOLENOID VALVE</u>	1 YEAR
<u>REPLACING THE DEGASSING AND/OR FILLING SOLENOID VALVE</u>	2 YEARS

(*) *The frequencies given are for information and must be adjusted by the operator depending on how the apparatus is used.*

4.3 REMEDIAL MAINTENANCE

Like every other system, your apparatus may be subject to an electrical, electronic or mechanical failure. The manufacturer cannot be held responsible for any type of stored products lost as a result of this failure, even during the guarantee period.

Maintenance operations shall be carried out by technicians who have received appropriate training.

There are four analysed configurations.

Indicators only:

Configuration ①, assembly composed of:

- ▶ a temperature indicatorACC-GNL-11
- ▶ a level indicatorACC-GNL-10
- ▶ a 4-channel power supplyACC-GNL-19

4.3.1 Temperature + regulated level indicator

Configuration ②, assembly composed of:

- ▶ a temperature indicatorACC-GNL-11
- ▶ a regulated level indicator - gasACC-GNL-5
or liquid.....ACC-GNL-12
- ▶ an anti-overflow kitACC-GNL-4
- ▶ a 4-channel power supplyACC-GNL-19
- ▶ ***optionally***, a degassing kitNH102850-1

4.3.2 Temperature & Level indicators + 4-20 mA unit

Configuration ③, assembly composed of:

- ▶ a temperature indicatorACC-GNL-11
- ▶ a level indicatorACC-GNL-10
- ▶ a 4-20 mA Liquid Alarm unit at 5%.....NH102899
OR a 4-20 mA Liquid Alarm unit at 10%NH102900
OR a 4-20 mA Gas Alarm unit at 15%.....NH102901
- ▶ an anti-overflow kitACC-GNL-4
- ▶ a 4-channel power supplyACC-GNL-19
- ▶ ***optionally***, a degassing kitNH102850-1

4.3.3 Temperature & Level indicators + RS485 unit

Configuration ④, assembly composed of:

- ▶ a temperature indicatorACC-GNL-11
- ▶ a level indicatorACC-GNL-10
- ▶ an RS485 unitACC-GNL-13
- ▶ an anti-overflow kitACC-GNL-4
- ▶ a 4-channel power supplyACC-GNL-19
- ▶ ***optionally***, a degassing kitNH102850-1

4.3.4 Functional anomalies

For CONFIG	OBSERVED ANOMALY	PROBABLE CAUSE(S) OF THE ANOMALY	REMEDY(IES) FOR THE ANOMALY
① ② ③ ④	You cannot open the lid	The lock is locked	Unlock the lock
		The lock is blocked and not iced	Replace the lock ③
		The lid is iced on the device neck	De-ice the lid
① ② ③ ④	One or both of the indicators does not light up	Mains power supply disconnected	Reconnect the cable
		Mains power supply cable broken	Reconnect the cable ③
		Power supply fuse burned out	Replace the fuse ① or ③
		Indicator power supply cable disconnected	Reconnect the indicator power supply cable
		Indicator power supply cable broken	Replace the indicator power supply cable ③
		Defective indicator	Replace the indicator ③
①②③ ④	Incorrect temperature reading	Temperature probe cable badly connected	Reconnect the temperature probe cable
		Incorrect temperature unit (°C / °F)	Reset your indicator parameters ① ②
		Temperature probe damaged	Replace the temperature probe ③
		Defective indicator	Replace the indicator ③
①②③ ④	Incorrect level reading	Level gauge cable badly connected	Reconnect the level gauge cable
		Bad calibration	Have the indicator + level gauge assembly checked and/or recalibrated ②
		Defective indicator	Replace the indicator ③
①②③ ④	'ERR SONDE' (probe error) message	Temperature probe or level gauge damaged	Replace the temperature probe or the level gauge ③
		Temperature probe or level gauge cable broken	
①②③ ④	'ERR ELECTRONIQUE' (electronic error) message	Defective temperature indicator (exclusively)	Replace the indicator ③
①②③ ④	'ERR MESURE' (measurement error) message	Measurement outside range	Wait until the measurement is within the range
		Incorrect empty and/or full calibration	Re-calibrate your indicator ① ②
①②③ ④	'PARAMET ERROR' message	Temperature probe or level gauge damaged	Replace the temperature probe or the level gauge ③
		One or several previously recorded parameters is wrong	Reset your indicator parameters ① ②
①②③ ④	Malfunction of the alarm output (back terminal block on your indicator)	Alarm output disconnected or badly connected	Check that the alarm output is connected ①
		Defective temperature or level indicator	Replace the indicator ③
		Unsuitable device alarms parameter	Reset alarm parameters

For CONFIG	OBSERVED ANOMALY	PROBABLE CAUSE(S) OF THE ANOMALY	REMEDY(IES) FOR THE ANOMALY
①②③ ④	Malfunction of the visual alarm and buzzer (Indicator LED & buzzer)	Defective temperature or level indicator	Replace the indicator ③
		Defective anti-overflow probe	Replace the probe ③
		Defective anti-overflow system	Replace the system ③
② ③ ④	Filling level not respected	Level gauge failure	Check or replace the level gauge
		Electronics failure	Replace the electronics or contact the distributor
		Apparatus incorrectly calibrated	Contact the apparatus maintenance manager
		Unsuitable apparatus regulation levels parameter	Define new regulation level settings
② ③ ④	Permanent degassing of the apparatus	Defective degassing probe	Replace the probe ③
		Degassing probe disconnected	Reconnect the probe
		Solenoid valve not iced and blocked	Replace the solenoid valve ③
		Solenoid valve iced and blocked	De-ice the solenoid valve
		Defective degassing system	Replace the system
② ③ ④	Non-operation of the degassing kit	Defective degassing probe	Replace the probe ③
		Defective degassing system	Replace the system ③
		Solenoid valve power supply cable broken or disconnected	Check the condition of the cable and its connection, or replace it.
		Power supply cable disconnected	Reconnect the cable
		Power supply cable broken	Replace the power supply ③
		Power supply fuse burned out	Replace the fuse ① ③
		Degassing system power supply cable disconnected	Reconnect the mains cable
		Degassing system power supply cable broken	Replace the mains cable ①
③ ④	Unit fails to operate	Unit power supply cable broken	Replace the cable
		Unit power supply cable disconnected	Check the cable connection
		Unit fuse burned out	Replace the fuse ① ③
③④	No communication between the unit and the outside	Communication cable disconnected	Check the connection of the cable
		Communication cable broken	Replace the cable
		Failure of the electronics	Replace the unit ②
③④	No alarm output	Connection fault between the indicator and the unit	Check the connection
		Communication fault between the indicator and the unit	Check the communication ②

① Refer to the corresponding user guide for the procedure

② Contact the person responsible for the device

③ Refer to the corresponding user guide for the reference

5 WASTE ELIMINATION METHOD

All waste caused by use of the cryogenic apparatus (tubes, packs, etc.) must be eliminated using appropriate waste treatment systems.

Please contact your distributor for further information.











6 METHOD OF ELIMINATING THE CRYOGENIC CONTAINER

Appropriate systems must be used to eliminate the apparatus and to protect the environment. The AIR LIQUIDE Cryogenic Equipment Division must also be informed of the reference and serial number of the eliminated apparatus to maintain traceability imposed by the **CE** marking.

These data are given on the identity label at the back of the apparatus.

	AIR LIQUIDE - DIVISION MATERIEL CRYOGENIQUE PARC GUSTAVE EIFFEL - 8 RUE GUTENBERG BUSSY SAINT GEORGE - 77607 MARNE LA VALLE CEDEX 3 TEL. : (33) 164 761 500 -- FAX. : (33) 164 761 699 www.dmc.airliquide.com		
REF	<input type="text"/>		<input type="text"/>
SN	<input type="text"/>		<input type="text"/>
	<input type="text"/>	CE 0029	

7 SYMBOLS & ABBREVIATIONS

CE 0029	Conforming with directive 93/42/CEE June 14 1993, related to medical apparatuses		WARNING: Low temperature
	Manufacturer's name and address		COMPULSORY: Read the user guide
REF	Reference in the apparatus catalogue		COMPULSORY: Protect your hands using appropriate individual protection equipment
	Apparatus manufacturing date (WW/YY)		COMPULSORY: Protect your face using appropriate individual protection equipment
SN	Apparatus serial number		COMPULSORY: Keep the apparatus in an area that is sufficiently and permanently ventilated
	Net weight of the empty apparatus in kilograms		PROHIBITED: Do not touch parts that have been in contact with liquid nitrogen
	Volume of the device when full, in litres		

Apparatus means the Container + electronic equipment assembly already in your possession.

8 SPARE PARTS AND ACCESSORIES

The list in this chapter contains manufacturer's references for the proposed parts, so that you can write your part orders correctly.



AIR LIQUIDE declines all responsibility following:

- a modification of the apparatus and/or related equipment
- use of accessories/electronic apparatus not approved and referenced by the AIR LIQUID Cryogenic Equipment Division.

8.1 SPARE PARTS

	NATAL 40	ARPEGE 40	ARPEGE 70	ARPEGE 110	ARPEGE 140	ARPEGE 170	ARPEGE 55/75
Lid	ACC-GT-3	ACC- ARP-308	ACC-ARP-307				ACC-ARP- 306
Capacitive level gauge	ACC-ARP-201		ACC-ARP- 202	ACC-ARP- 203	ACC-ARP- 204	ACC-ARP- 205	ACC-ARP- 200
Capacitive gas level gauge			NH103493-1	NH103493-2	NH103493-3	NH103493-4	
Filling tube for Arpege gas phase			NH103611-1	NH103611-2	NH103611-3	NH103611-4	
Tube and gas phase gauge assembly			ACC-ARP- 402	ACC-ARP- 403	ACC-ARP- 404	ACC-ARP- 405	
Temperature probe	ACC-GNL-2						
Temperature indicator unit	ACC-GNL-11						
Level indicator unit	ACC-GNL-10						
Liquid level regulation unit	ACC-GNL-12						
Liquid level regulation gas	ACC-GNL-5						
24 V solenoid valve	ACC-GNL-1						
220/4 x 24V power supply unit	ACC-GNL-19						

8.2 ACCESSORIES/OPTIONS

TYPE	ARPEGE 40	ARPEGE 70	ARPEGE 110	ARPEGE 140	ARPEGE 170	ARPEGE 55/75
Level indicator OPTION	ACC-ARP-7	ACC-ARP-10	ACC-ARP-17	ACC-ARP-24	ACC-ARP-31	ACC-ARP-2
Temperature indicator OPTION	ACC-ARP-8	ACC-ARP-11	ACC-ARP-18	ACC-ARP-25	ACC-ARP-32	
Level + T° indicator OPTION	ACC-ARP-9	ACC-ARP-12	ACC-ARP-19	ACC-ARP-26	ACC-ARP-33	ACC-ARP-5
Level Regulation OPTION		ACC-ARP-13	ACC-ARP-20	ACC-ARP-27	ACC-ARP-34	ACC-ARP-4
Level + T° Regulation OPTION		ACC-ARP-14	ACC-ARP-21	ACC-ARP-28	ACC-ARP-35	ACC-ARP-6
Level Regulation OPTION with degassing System						ACC-ARP-3
Level + T° Regulation OPTION with degassing System						ACC-ARP-1
Level + T° Regulation with 4-20 mA Remote Monitoring Unit OPTION		ACC-ARP-15	ACC-ARP-22	ACC-ARP-29	ACC-ARP-36	
Level + T° regulation with RS485 Remote Monitoring Unit OPTION		ACC-ARP-16	ACC-ARP-23	ACC-ARP-30	ACC-ARP-37	ACC-ARP-38
Bottom plate with rollers	ACC-ALU-9	ACC-ARP-305		ACC-ARP-304		ACC-ALU-9

8.3 INTERNAL EQUIPMENT

	NATAL 40	ARPEGE 40	ARPEGE 70	ARPEGE 110	ARPEGE 140	ARPEGE 170	ARPEGE 55	ARPEGE 75
Number of racks		6	4	4	6	6	6	6
Unit size (mm)		76 x 76	133 x 133	133 x 133	133 x 133	133 x 133	Cryo- plastic drawers	Cryo- plastic drawers
Number of storage levels (1 or 2 ml tubes)		5	5	9	8	10	9	12
Total capacity 1 or 2 ml tubes		750 (2 ml)	2000	3600	4800	6000	3618 (with 3015 gauge)	4824 (with 4020 gauge)
Number of storage levels (5 ml tubes)			3	5	4	5	1	2
Total capacity 5 ml tubes			972	1620	1944	2430	1071 (on rods)	2142 (on rods)
Capacity in 0.25 ml straws in canisters	16400						51660	68880

8.4 INTERNAL GAS PHASE EQUIPMENT

	NATAL 40	ARPEGE 40	ARPEGE 70	ARPEGE 110	ARPEGE 140	ARPEGE 170	ARPEGE 55	ARPEGE 75
Number of racks			4	4	6	6		
Unit size (mm)			133 x 133	133 x 133	133 x 133	133 x 133		
Number of storage levels (1 or 2 ml tubes)			4	8	7	9		
Total capacity 1 or 2 ml tubes			1600	3200	4200	5400		
Number of storage levels (5 ml tubes)			2	4	3	4		
Total capacity 5 ml tubes			648	1296	1458	1944		
Capacity in 0.25 ml straws in canisters								

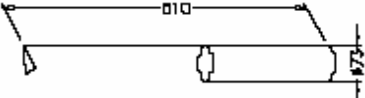
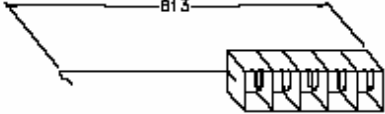
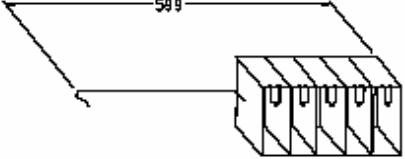
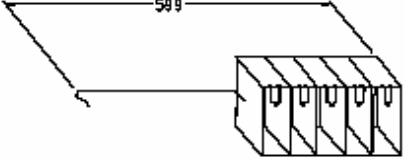
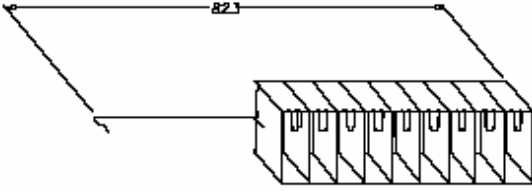
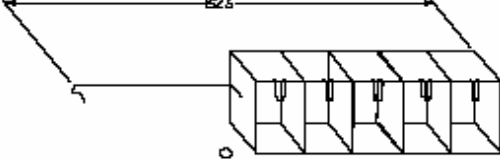
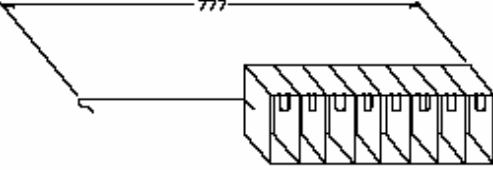
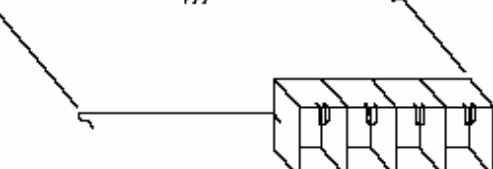
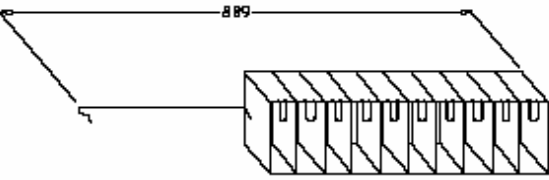
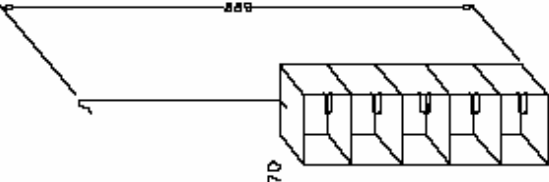
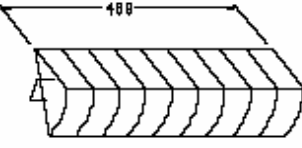
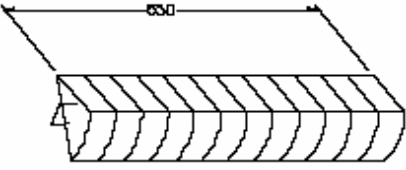
<p>GT40 / NATAL ACC-STEELCAN-3</p>  <p>16400 paillettes 0,25mL 7300 paillettes 0,5 mL 1200 tubes 2mL (Baguelette) 600 tubes 5mL (Baguelette)</p>	<p>ARPEGE 40 ACC-RACK-100</p>  <p>750 tubes 2mL (25)</p>	<p>ACC-RACK-101</p>  <p>1620 tubes 2mL (81) 2000 tubes 2mL (100)</p> <p>ARPEGE 70</p>  <p>972 tubes 5mL (81)</p>	<p>ACC-RACK-102</p>  <p>2818 tubes 2mL (81) 3600 tubes 2mL (100)</p> <p>ARPEGE 110</p>  <p>ACC-RACK-106 1820 tubes 5mL (81)</p>	<p>ACC-RACK-103</p>  <p>3888 tubes 2mL (81) 4800 tubes 2mL (100)</p> <p>ARPEGE 140</p>  <p>ACC-RACK-107 1944 tubes 5mL (81)</p>	<p>ACC-RACK-104</p>  <p>4880 tubes 2mL (81) 6000 tubes 2mL (100)</p> <p>ARPEGE 170</p>  <p>ACC-RACK-108 2430 tubes 5mL (81)</p>	<p>ARPEGE 55 ACC-RACK-27</p>  <p>3818 tubes 2mL (81) Comptoirs, Tubes ou Paillettes voir tableau</p>	<p>ARPEGE 75 ACC-RACK-26</p>  <p>4824 tubes 2mL (81) Comptoirs, Tubes ou Paillettes VOIR tableau</p>
---	---	--	---	---	--	--	--

9 APPENDIX

Regardless of the version of your ARPEGE and its finish, the devices described below will always be in the same location (the diagram shows an ARPEGE 55)

